

ASBV.../LED

4 + PE

Aktor-/Sensor-Verteiler mit LED-Betriebs- und Funktionsanzeige, 4-, 6- und 8-fach, kombinierte FIXCON-/M12-Buchse, 5-polig, 2 Signale pro Buchse, Erdanschluss, fest angeschlossenes Kabel

Actuator/sensor distribution box with LED operation and function indicators, 4, 6 and 8 ports, combined FIXCON/M12 socket, 5 poles, 2 signals per socket, earth connection, integrated control cable

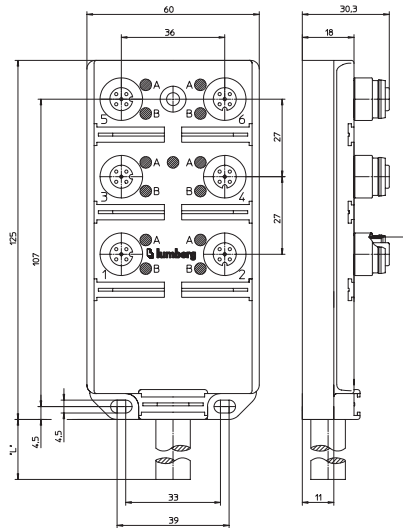
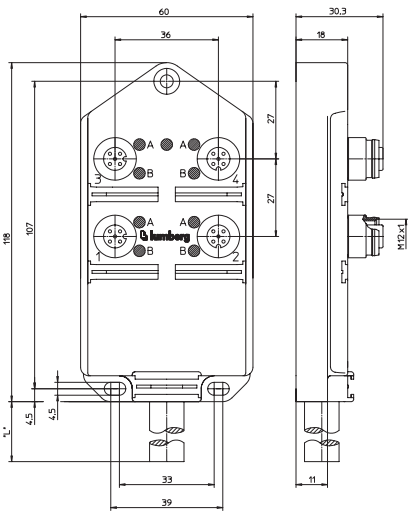
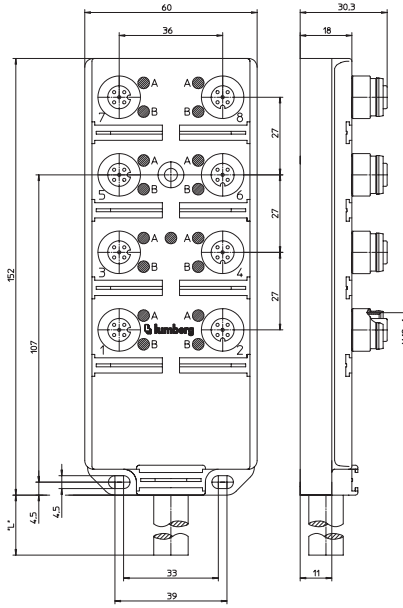

Pinbelegung / Schaltbild Pin assignment / wiring diagram

4-fach 4 ports

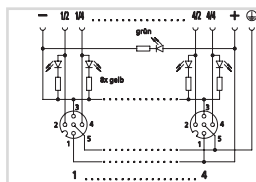

6-fach 6 ports

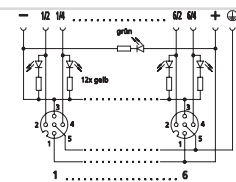

8-fach 8 ports

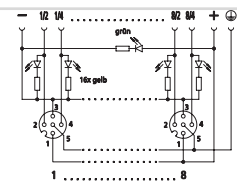













- 1 = braun / brown (+)
- 2 = grau/rosa / grey/pink (1)
- rot/blau / red/blue (2)
- weiß/grün / white/green (3)
- braun/grün / brown/green (4)
- 3 = blau / blue (-)
- 4 = weiß / white (1)
- grün / green (2)
- gelb / yellow (3)
- grau / grey (4)
- 5 = grün/gelb / green/yellow (PE)

- 1 = braun / brown (+)
- 2 = grau/rosa / grey/pink (1)
- rot/blau / red/blue (2)
- weiß/grün / white/green (3)
- braun/grün / brown/green (4)
- weiß/gelb / white/yellow (5)
- gelb/braun / yellow/brown (6)
- 3 = blau / blue (-)
- 4 = weiß / white (1)
- grün / green (2)
- gelb / yellow (3)
- grau / grey (4)
- rosa / pink (5)
- rot / red (6)
- 5 = grün/gelb / green/yellow (PE)

- 1 = braun / brown (+)
- 2 = grau/rosa / grey/pink (1)
- rot/blau / red/blue (2)
- weiß/grün / white/green (3)
- braun/grün / brown/green (4)
- weiß/gelb / white/yellow (5)
- gelb/braun / yellow/brown (6)
- weiß/grau / white/grey (7)
- grau/braun / grey/brown (8)
- 3 = blau / blue (-)
- 4 = weiß / white (1)
- grün / green (2)
- gelb / yellow (3)
- grau / grey (4)
- rosa / pink (5)
- rot / red (6)
- schwarz / black (7)
- violett / violet (8)
- 5 = grün/gelb / green/yellow (PE)

Technische Daten		Technical data	
Umgebungstemperatur	-15°C / +80°C	Operating temperature range	-15°C / +80°C
Werkstoffe		Materials	
Gehäuse / Griffkörper	TPU, selbstverlöschend	Housing / Molded body	TPU, self-extinguishing
Kontaktträger	PA GF, selbstverlöschend	Insert	PA GF, self-extinguishing
Kontakt	CuZn, unternickelt und 0,8 µm vergoldet	Contact	CuZn, pre-nickelated and 0.8 microns gold-plated
Gewindebuchse / Rändelschraube/-mutter / Sechskantschraube/-mutter / Hülse	CuZn, vernickelt	Receptacle shell / knurled screw/nut / hexagon screw/nut / sleeve	CuZn, nickel-plated
O-Ring	FKM	O-ring	FKM
Mechanische Daten		Mechanical data	
Schutzart	IP 67 Nur im verriegelten oder verschraubten Zustand mit den dazugehörigen Gegenstücken oder Schutzkappen.	Degree of protection	IP 67 Only in locked position with its proper counterparts or dust covers.
Elektrische Daten		Electrical data	
Durchgangswiderstand	≤ 5 mΩ	Contact resistance	≤ 5 mΩ
Nennstrom bei 40°C	4 A pro Steckplatz / 12 A max. gesamt	Nominal current at 40°C	4 A per outlet / 12 A max. total
Nennspannung	10–30 V DC	Nominal voltage	10–30 V DC
Bemessungsspannung	32 V	Rated voltage	32 V
Isolationswiderstand	> 10 ⁹ Ω	Insulation resistance	> 10 ⁹ Ω
Verschmutzungsgrad	3	Pollution degree	3
Zubehör (inkl.)		Accessories (incl.)	
ZVK	2 Schutzkappen für nicht belegte Kupplungsgehäuse	ZVK	2 dust covers for unused sockets
ZBS	10 Beschriftungsschilder	ZBS	10 attachable labels

Bestellbezeichnung Designation	Ausführung Version	Mantel Outer jacket	
ASBV 4/LED 5-256/... M	4-fach / 4 ports	PUR halogenfrei / halogen free	   
ASBV 6/LED 5-332/... M	6-fach / 6 ports	PUR halogenfrei / halogen free	   
ASBV 8/LED 5-242/... M	8-fach / 8 ports	PUR halogenfrei / halogen free	   
Standardlängen: 5 M / 10 M / 15 M Andere Kabellängen oder Leitungsaufbauten auf Anfrage.		Standard lengths: 5 M / 10 M / 15 M Other cable lengths or cable specifications on request.	