

RKF.../11

Einbausteckverbinder, 7/8"-Kupplung für die Frontmontage, konfektioniert mit Schaltlitze, Leiteranschlussbereich vergossen, einbauseitig PG 11-Verschraubung (Befestigung über RSKF 11)

Receptacle connector, 7/8" female connector for front mounting, assembled stranded wire, solder contacts potted with epoxy, chassis side thread PG 11 (panel nut RSKF 11)

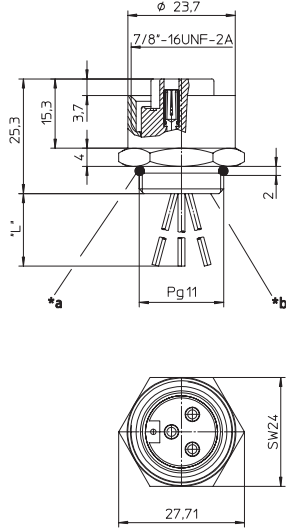

RKF.../13,5

Einbausteckverbinder, 7/8"-Kupplung für die Frontmontage, konfektioniert mit Schaltlitze, Leiteranschlussbereich vergossen, einbauseitig PG 13,5-Verschraubung (Befestigung über RSKF 13,5)

Receptacle connector, 7/8" female connector for front mounting, assembled stranded wire, solder contacts potted with epoxy, chassis side thread PG 13,5 (panel nut RSKF 13,5)

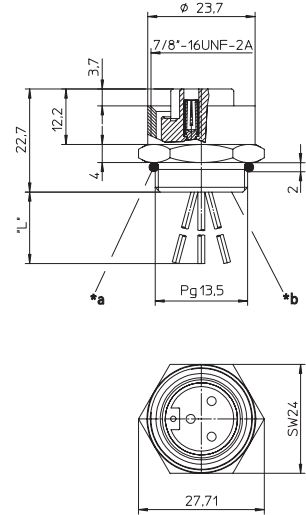

*a O-Ring lose beigestellt
O-ring enclosed separately
*b Leiteranschlussbereich vergossen
solder contacts potted with epoxy

*a O-Ring lose beigestellt
O-ring enclosed separately
*b Leiteranschlussbereich vergossen
solder contacts potted with epoxy

Pinbelegung Pin assignment

2-polig 2 poles

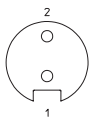

1 = braun / brown
2 = blau / blue

3-polig 3 poles

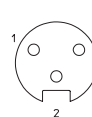

1 = braun / brown
2 = schwarz / black
3 = blau / blue

4-polig 4 poles

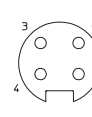

1 = braun / brown
2 = weiß / white
3 = blau / blue
4 = schwarz / black



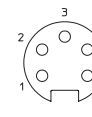

5-polig 5 poles



1 = schwarz / black
2 = blau / blue
3 = grün/gelb / green/yellow
4 = braun / brown
5 = weiß / white

Technische Daten	
Umgebungstemperatur	-25°C / +90°C
Werkstoffe	
Gehäuse / Griffkörper	CuZn, vernickelt
Kontaktträger	TPU, selbstverlöschend
Kontakt	CuSn, versilbert und 0,3 µm vergoldet
Mechanische Daten	
Schutzart	IP 68 (1h bei 10 bar) Nur im verschraubten Zustand mit den dazugehörigen Gegenstücken.
Elektrische Daten	
Durchgangswiderstand	≤ 5 mΩ
Nennstrom bei 40°C	2- bis 3-polig 12 A 4- bis 5-polig 9 A
Nennspannung	240 V
Bemessungsspannung	250 V
Prüfspannung	3- bis 4-polig 2,5 kV eff. / 60 s 5-polig 1,5 kV eff. / 60 s
Isolationswiderstand	> 10 ⁹ Ω
Verschmutzungsgrad	3

Technical data	
Operating temperature range	-25°C / +90°C
Materials	
Housing / Molded body	CuZn, nickel-plated
Insert	TPU, self-extinguishing
Contact	CuSn, silver-plated and 0.3 microns gold-plated
Mechanical data	
Degree of protection	IP 68 (1h at 10 bar) Only in locked position with its proper counterparts.
Electrical data	
Contact resistance	≤ 5 mΩ
Nominal current at 40°C	2–3 poles 12 A 4–5 poles 9 A
Nominal voltage	240 V
Rated voltage	250 V
Test voltage	3–4 poles 2.5 kV eff. / 60 s 5 poles 1.5 kV eff. / 60 s
Insulation resistance	> 10 ⁹ Ω
Pollution degree	3

Bestellbezeichnung Designation		Polzahl Poles	
RKF 20/11-03	RKF 20/13,5-03	2	
RKF 30/11-01	RKF 30/13,5-01	3	
RKF 30/11-05	RKF 30/13,5-05		
RKF 40/11-02	RKF 40/13,5-02	4	
RKF 50/11-04	RKF 50/13,5-04	5	