

### RKC 30-RKC 50

Konfektionierbarer Steckverbinder, 7/8"-Kupplung mit Schraubverschluss, Konfektionierung über Schraubklemmen

Field attachable connector, 7/8" female connector with threaded joint, assembling with screw terminals

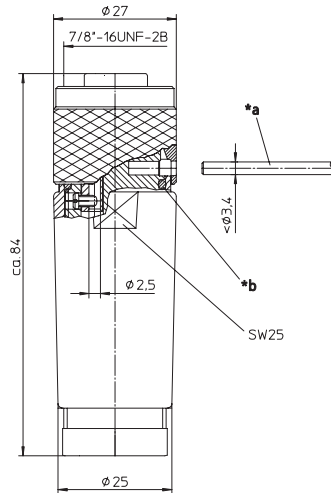

- \*a Stift oder Schraubendreher als Montagehilfe  
pin or screwdriver as assembly tool
- \*b O-Ring  
O-ring

### Pinbelegung Pin assignment

**3-polig  
3 poles**

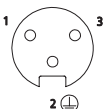

**4-polig  
4 poles**

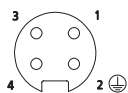



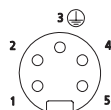







**5-polig  
5 poles**



<b>Technische Daten</b>	
<b>Umgebungstemperatur</b>	-40°C / +90°C
<b>Werkstoffe</b>	
Gehäuse / Griffkörper	PA
Kontaktträger	TPU, selbstverlöschend
Kontakt	CuZn, unternickelt und 0,8 µm vergoldet
Gewindebuchse / Rändelschraube/-mutter / Sechskantschraube/-mutter / Hülse	Al eloxiert
O-Ring	NBR
<b>Mechanische Daten</b>	
Schutzart	IP 67 Nur im verschraubten Zustand mit den dazugehörigen Gegenstücken.
Anschlussart	Schraubanschluss
Anschließbarer Leiter	max. 1,0 mm <sup>2</sup>
<b>Elektrische Daten</b>	
Durchgangswiderstand	≤ 5 mΩ
Nennstrom bei 40°C	3-polig 12 A 4- bis 5-polig 9 A
Nennspannung	240 V
Bemessungsspannung	250 V
Prüfspannung	2,5 kV eff. / 60 s
Isolationswiderstand	> 10 <sup>9</sup> Ω
Verschmutzungsgrad	3

<b>Technical data</b>	
<b>Operating temperature range</b>	-40°C / +90°C
<b>Materials</b>	
Housing / Molded body	PA
Insert	TPU, self-extinguishing
Contact	CuZn, pre-nickel and 0.8 microns gold-plated
Receptacle shell / knurled screw/nut / hexagon screw/nut / sleeve	Al anodized
O-ring	NBR
<b>Mechanical data</b>	
Degree of protection	IP 67 Only in locked position with its proper counterparts.
Mode of connection	screw terminals
Connectable conductor	max. 1.0 mm <sup>2</sup>
<b>Electrical data</b>	
Contact resistance	≤ 5 mΩ
Nominal current at 40°C	3 poles 12 A 4–5 poles 9 A
Nominal voltage	240 V
Rated voltage	250 V
Test voltage	2.5 kV eff. / 60 s
Insulation resistance	> 10 <sup>9</sup> Ω
Pollution degree	3

Bestellbezeichnung Designation	Polzahl Poles	Kabelverschraubung Screw joint for cable	
RKC 30/9	3	Ø 6,0–8,0 mm	 
RKC 30/11		Ø 8,0–10,0 mm	 
RKC 40/9	4	Ø 6,0–8,0 mm	 
RKC 50/9		Ø 6,0–8,0 mm	 
RKC 50/11	5	Ø 8,0–10,0 mm	 
RKC 50/16		Ø 12,0–14,0 mm	