

RSUF

Anschlussleitung, M23-Stecker mit Schraubverschluss, Außengewinde und angespritztem Kabel

Cordset, single-ended, M23 male connector with threaded joint, external thread and molded cable

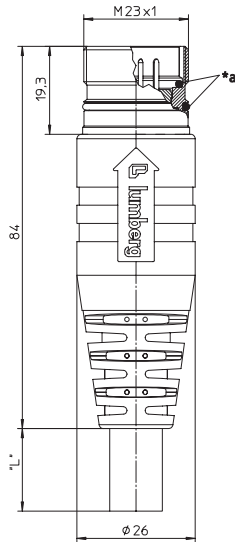

*a O-Ring
O-ring

RSWUF

Anschlussleitung, M23-Winkel-Stecker mit Schraubverschluss, Außengewinde und angespritztem Kabel

Cordset, single-ended, M23 male right angle connector with threaded joint, external thread and molded cable

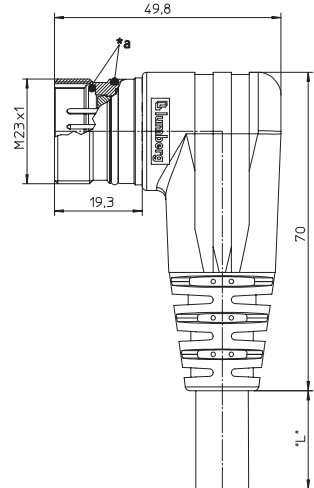

*a O-Ring
O-ring

Pinbelegung
Pin assignment

12-polig
12 poles

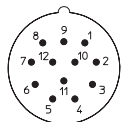

- 1 = weiß / white
- 2 = grün / green
- 3 = gelb / yellow
- 4 = grau / grey
- 5 = grau/rosa / grey/pink
- 6 = rot/blau / red/blue
- 7 = weiß/grün / white/green
- 8 = braun/grün / brown/green
- 9 = blau / blue
- 10 = blau / blue
- 11 = braun / brown
- 12 = gelb/grün / yellow/green



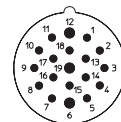



19-polig
19 poles



- 1 = violett / violet
- 2 = rot / red
- 3 = grau / grey
- 4 = rot/blau / red/blue
- 5 = grün / green
- 6 = blau / blue
- 7 = grau/rosa / grey/pink
- 8 = weiß/grün / white/green
- 9 = weiß/gelb / white/yellow
- 10 = weiß/grau / white/grey
- 11 = schwarz / black
- 12 = gelb/grün / yellow/green
- 13 = gelb/braun / yellow/brown
- 14 = braun/grün / brown/green
- 15 = weiß / white
- 16 = gelb / yellow
- 17 = rosa / pink
- 18 = grau/braun / grey/brown
- 19 = braun / brown

Anschlussleitungen für Aktoren, Sensoren und Verteiler Cordsets, single-ended, for actuators, sensors and distribution boxes

Technische Daten		Technical data	
Umgebungstemperatur	-25°C / +100°C	Operating temperature range	-25°C / +100°C
Werkstoffe		Materials	
Gehäuse / Griffkörper	TPU, selbstverlöschend	Housing / Molded body	TPU, self-extinguishing
Kontaktträger	PBT	Insert	PBT
Kontakt	CuZn, unternickelt und 0,8 µm vergoldet	Contact	CuZn, pre-nickeled and 0.8 microns gold-plated
Gewindebuchse / Rändelschraube/-mutter / Sechskantschraube/-mutter / Hülse	CuZn, vernickelt	Receptacle shell / knurled screw/nut / hexagon screw/nut / sleeve	CuZn, nickel-plated
O-Ring	FKM	O-ring	FKM
Mechanische Daten		Mechanical data	
Schutzart	IP 67 Nur im verschraubten Zustand mit den dazugehörigen Gegenstücken.	Degree of protection	IP 67 Only in locked position with its proper counterparts.
Elektrische Daten		Electrical data	
Durchgangswiderstand	≤ 5 mΩ	Contact resistance	≤ 5 mΩ
Nennstrom bei 40°C	12-polig 8 A 19-polig 8 A Stift-Ø 1 mm, 10 A Stift-Ø 1,5 mm	Nominal current at 40°C	12 poles 8 A 19 poles 8 A pin Ø 1 mm, 10 A pin Ø 1.5 mm
Nennspannung	12-polig 240 V 19-polig 120 V	Nominal voltage	12 poles 240 V 19 poles 120 V
Bemessungsspannung	12-polig 250 V 19-polig 125 V	Rated voltage	12 poles 250 V 19 poles 125 V
Prüfspannung	12-polig 2,5 kV eff./ 60 s 19-polig 1,5 kV eff./ 60 s	Test voltage	12 poles 2.5 kV eff./ 60 s 19 poles 1.5 kV eff./ 60 s
Isolationswiderstand	> 10 ⁹ Ω	Insulation resistance	> 10 ⁹ Ω
Verschmutzungsgrad	3	Pollution degree	3

Bestellbezeichnung Designation		Polzahl Poles	Mantel Outer jacket	
RSUF 12-256/... M	RSWUF 12-256/... M	12	PUR halogenfrei / halogen free	  
RSUF 19-242/... M	RSWUF 19-242/... M	19	PUR halogenfrei / halogen free	  
Standardlängen: 5 M / 10 M / 15 M / 20 M Andere Kabellängen oder Leitungsaufbauten auf Anfrage.			Standard lengths: 5 M / 10 M / 15 M / 20 M Other cable lengths or cable specifications on request.	