

heavy duty hinge 40x40
for 40 series profiles

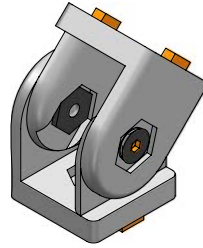
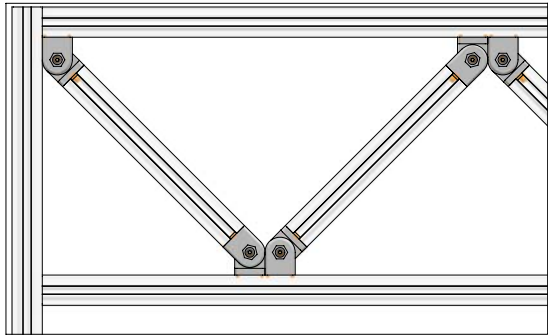

heavy duty hinge 40x40
Part Number 373.31

for connecting profiles at various angles, suits 40 series profiles supplied with eight locating blocks

Material: Zn/cast

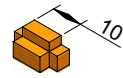
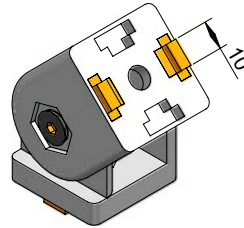

locating block inserted into hinge base according to aluminium profile slot direction

four blocks for end profile connection

two blocks for profile slot connection

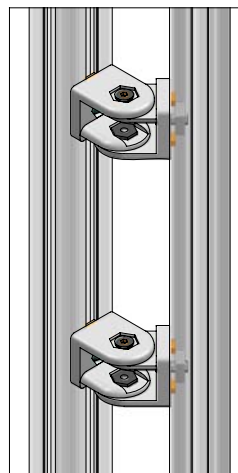
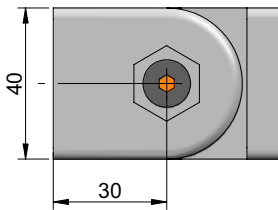
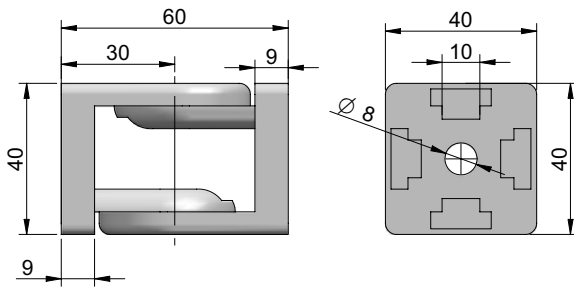

1.

possible uses:
1. heavy doors
2. swivel type arm

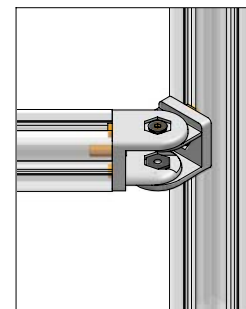

2.